

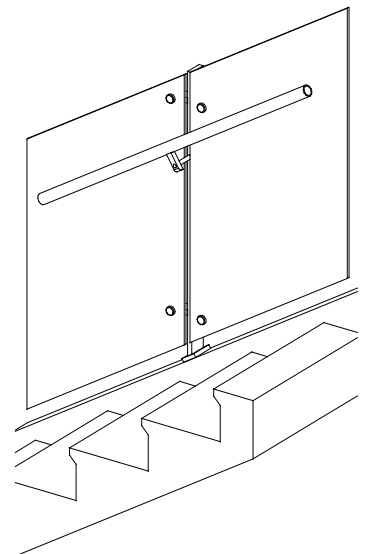

700 Creel Drive
Wood Dale, IL 60191
Office: 630.860.2990
Fax: 630.860.5913
artec-rail.com

CHICAGO SYSTEM

TECHNICAL DETAILS

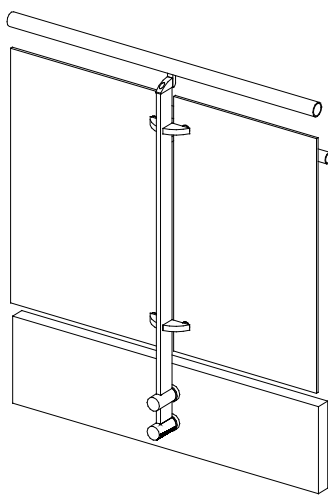
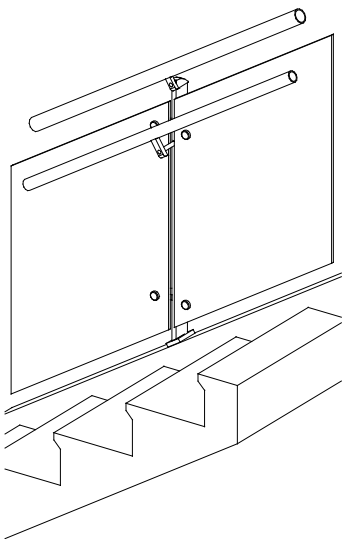

SYSTEM: CHICAGO

COVER SHEET

NO SCALE

CHICAGO SYSTEM

REVISION 2021-02

SHEET C-01 of 29